

calendarios

2025

PAPEL DIGITAL CABECERAS DE CALENDARIOS

- Tamaños y gramajes especiales impresoras A3 Plus
XEROX - KONICA MINOLTA - RICOH y otras
- Estucado brillo 2 caras

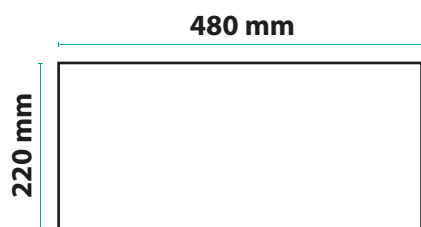

lechero 21 cm.

GRAMAJE | - 250 grs
- 300 grs
- 350 grs

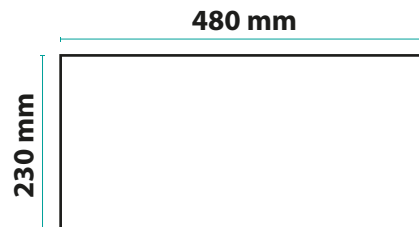

lechero 23,5 cm.

GRAMAJE | - 250 grs
- 300 grs
- 350 grs

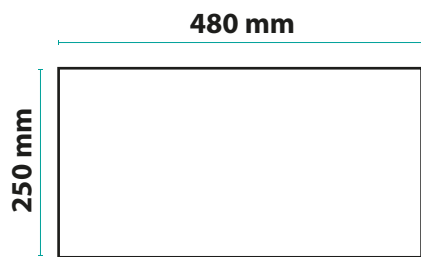

calendarios 31,5 - 33,5 - 43,5 cm.

GRAMAJE | - 300 grs
- 350 grs

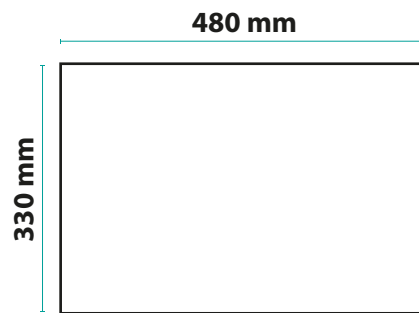

43,5 - 47 - 48,5 cm.

GRAMAJE | -157 grs (paq 250)
- 250 grs
- 300 grs
- 350 grs

CATALOGO LÁMINAS

2025



LÁMINA PEQUEÑA (LP)

Tamaño: 235 x 330 mm

Publicidad: 215 x 70 mm

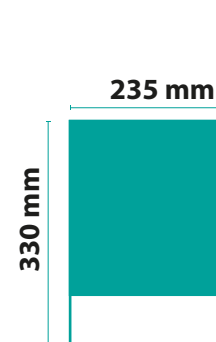

LÁMINA GRANDE (LG)

Tamaño: 315 x 480 mm

Publicidad: 295 x 90 mm

Impresión realizada en
papel estucado de 150 grs.

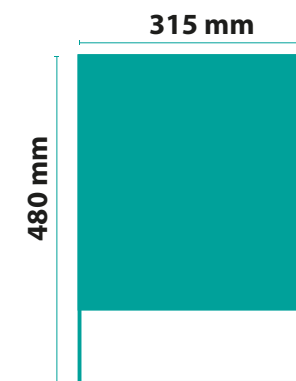

www.senande.com



Banff, Canadá

LP- 001



Königsee, Alemania

LP- 002 | **LG- 102**



Alpes, Italia

LP- 003 | **LG- 103**



Tailandia

LP- 004



Dolomitas

LP- 005



Islandia

LP- 006 | **LG- 106**



Pamplona

LP- 007



Asturias

LP- 008

LG- 108



Salamanca

LP- 009

LG- 109



Yuste

LP- 010



Vigo

LP- 011

LG- 111



Patio Andaluz

LP- 012



LP-013 | **LG-113**



LP-014



LP-015 | **LG-115**



LP-016



LP-017 | **LG-117**



LP-018 | **LG-118**



LP- 019 | **LG- 119**



LP- 020



LP- 021 | **LG- 121**



LP- 022 | **LG- 122**



LP- 023 | **LG- 123**



LP- 024 | **LG- 124**



LP- 025



LP- 026 | **LG- 126**



LP- 027 | **LG- 127**



LP- 028 | **LG- 128**



LP- 029 | **LG- 129**



LP- 030 | **LG- 130**



LP- 031 | **LG- 131**



LP- 032



LP- 033



LP- 034



LP- 035



LP- 036 | **LG- 136**



LP- 037



LP- 038



LP- 039

LG- 139



LP- 040

LG- 140



LP- 041



LP- 042

LG- 142



LP- 043



LP- 044

LG- 144



LP- 045



LP- 046

LG- 146



LP- 047

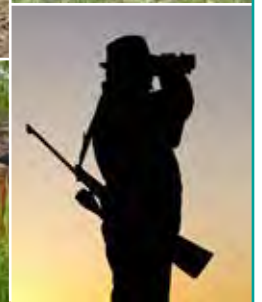

LP- 048



LP- 049 | **LG- 149**



LP- 050 | **LG- 150**



LP- 051 | **LG- 151**



LP- 052



LP- 053 | **LG- 153**

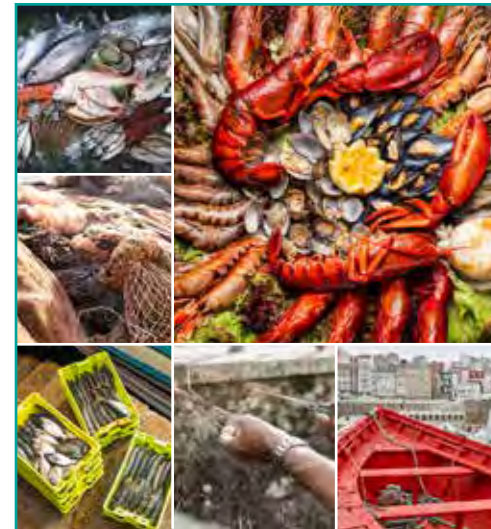

LP- 054 | **LG- 154**



LP- 055 | **LG- 155**

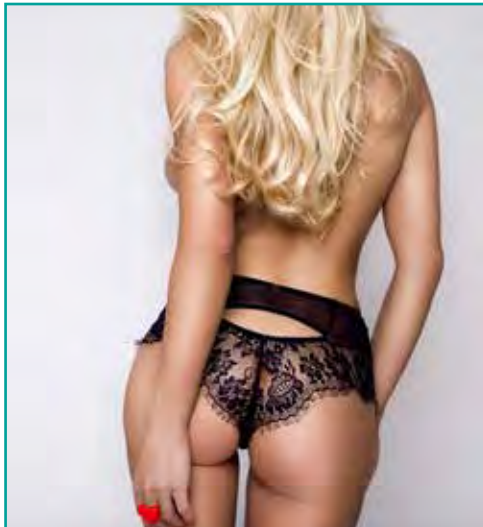

LP- 056



LP- 057 | **LG- 157**



LP- 058



LP- 059



LP- 060 | **LG- 160**



LP- 061

LG- 161



LP- 062

LG- 162



LP- 063

LG- 163



LP- 064

LG- 164



LP- 065

LG- 165



LP- 066

LG- 166



LP- 067

LG- 167

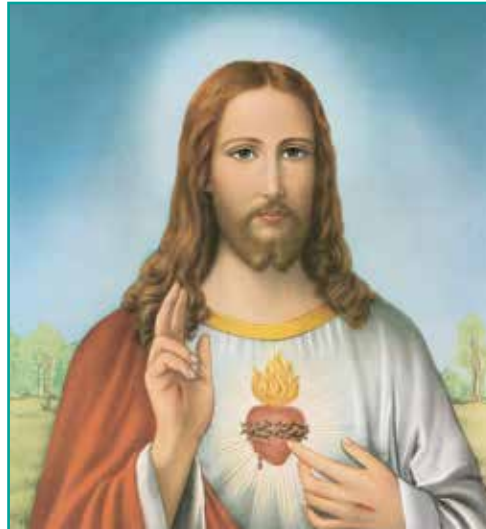

Sagrado Corazón de Jesús

LP- 068

LG- 168

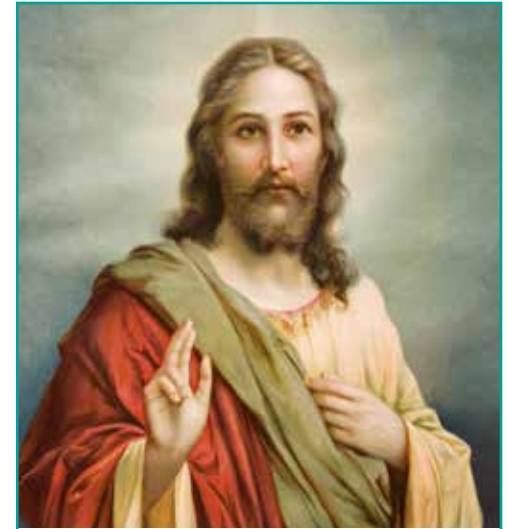

LP- 069

LG- 169



LP- 070

LG- 170



Sagrado Corazón de María

LP- 071

LG- 171



Virgen del Carmen

LP- 072

LG- 172



Inmaculada Concepción

LP- 073

LG- 173



Sagrada Familia

LP- 074

LG- 174



San Cristóbal

LP- 075

LG- 175



San Pancracio

LP- 076

LG- 176



San José

LP- 077

LG- 177

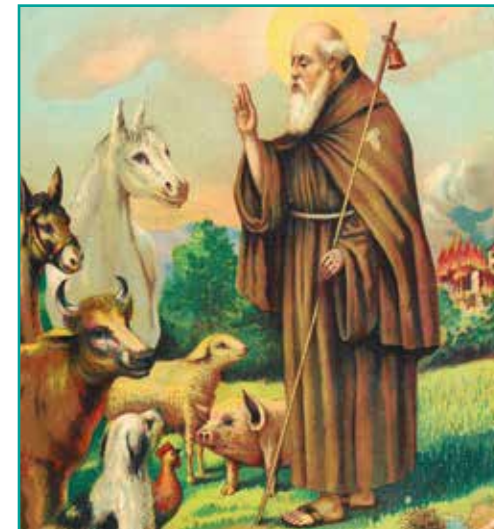

San Antonio

LP- 078

LG- 178

LÁMINAS · ESPECIALES

Láminas Especiales también con sus fotos

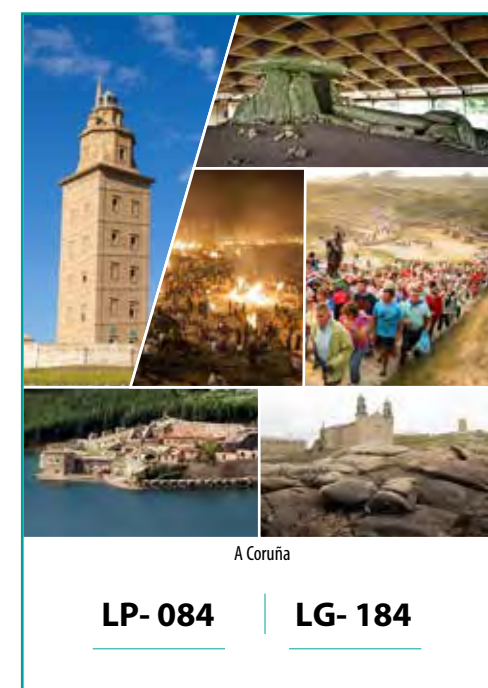
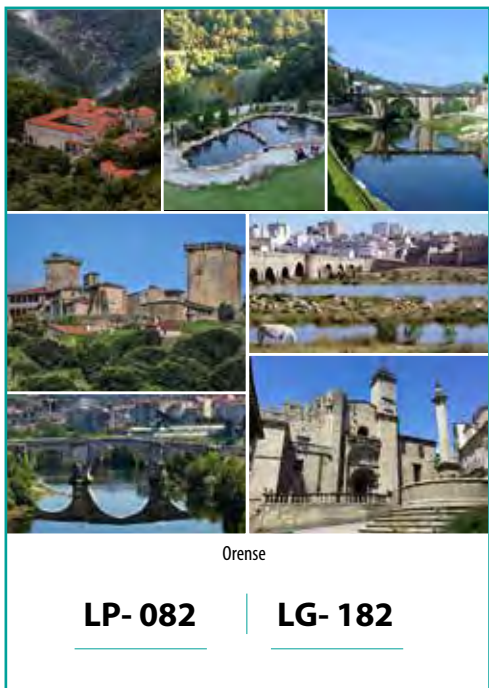
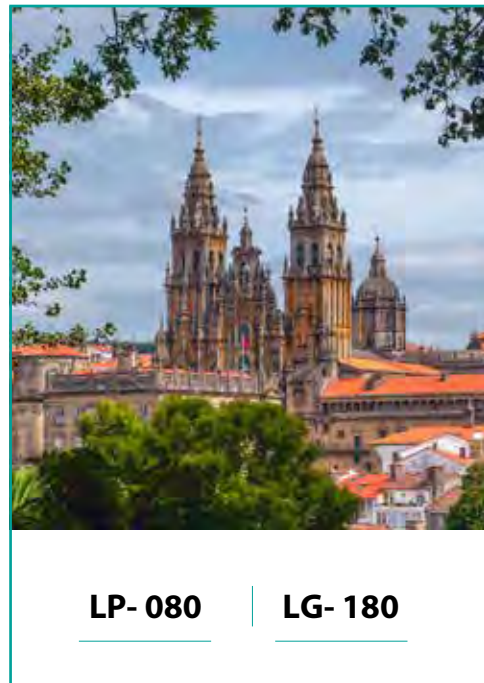



LP-085

LG-185



LP-086

LG-186



LP-087

LG-187



LP-088

LG-188



LP-089

LG-189



LP-090

LG-190

Láminas Especiales también con sus fotos

LÁMINAS · ESPECIALES

CALENDARIOS TARJETA DE CRÉDITO

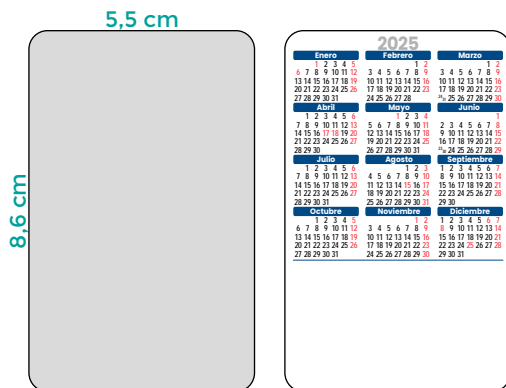

- Tamaño: 5,5 x 8.6 cm
- Publicidad: 5 x 3,2 cm
- Cartón 235 g.
- Plastificado una cara
- Calendario anual en el dorso

Información adicional

- Cada paquete consta de 13 hojas de 17,2 x 22 cm con 8 imágenes cada una, en total 104 unidades.

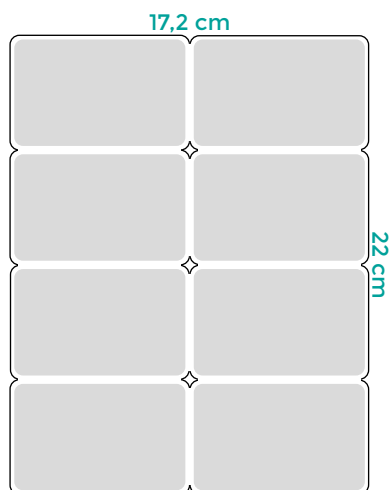

Paisajes internacionales

Ref. 79.0001



Vistas de España

Ref. 79.0002

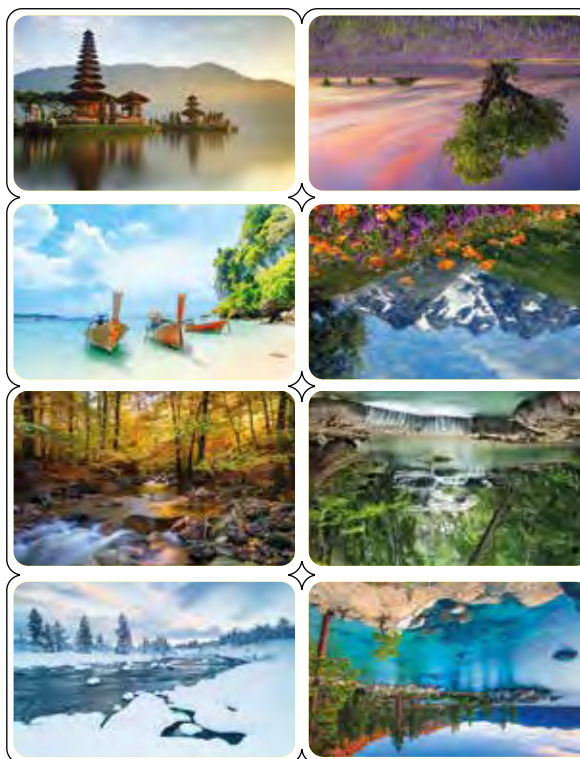



Niños

Ref. 79.0003



Mascotas

Ref. 79.0004

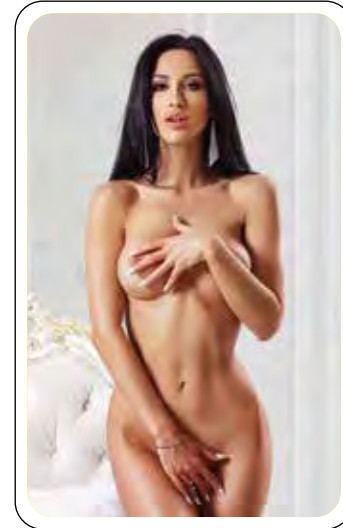

Chicas

Ref. 79.0005



CALENDARIOS TARJETA DE CRÉDITO

2025						
Enero		Febrero		Marzo		
L	M	M	J	V	S	D
1	2	3	4	5	6	1
6	7	8	9	10	11	12
13	14	15	16	17	18	19
20	21	22	23	24	25	26
27	28	29	30	31		
Abril		Mayo		Junio		
L	M	M	J	V	S	D
1	2	3	4	5	6	1
7	8	9	10	11	12	13
14	15	16	17	18	19	20
21	22	23	24	25	26	27
28	29	30	31			
Julio		Agosto		Septiembre		
L	M	M	J	V	S	D
1	2	3	4	5	6	1
7	8	9	10	11	12	13
14	15	16	17	18	19	20
21	22	23	24	25	26	27
28	29	30	31			
Octubre		Noviembre		Diciembre		
L	M	M	J	V	S	D
1	2	3	4	5	6	1
6	7	8	9	10	11	12
13	14	15	16	17	18	19
20	21	22	23	24	25	26
27	28	29	30	31		

Dorso blanco

Ref. 79.0006

2025						
Enero		Febrero		Marzo		
L	M	M	J	V	S	D
1	2	3	4	5	6	1
6	7	8	9	10	11	12
13	14	15	16	17	18	19
20	21	22	23	24	25	26
27	28	29	30	31		
Abril		Mayo		Junio		
L	M	M	J	V	S	D
1	2	3	4	5	6	1
7	8	9	10	11	12	13
14	15	16	17	18	19	20
21	22	23	24	25	26	27
28	29	30	31			
Julio		Agosto		Septiembre		
L	M	M	J	V	S	D
1	2	3	4	5	6	1
7	8	9	10	11	12	13
14	15	16	17	18	19	20
21	22	23	24	25	26	27
28	29	30	31			
Octubre		Noviembre		Diciembre		
L	M	M	J	V	S	D
1	2	3	4	5	6	1
6	7	8	9	10	11	12
13	14	15	16	17	18	19
20	21	22	23	24	25	26
27	28	29	30	31		



Chistes

Ref. 79.0007

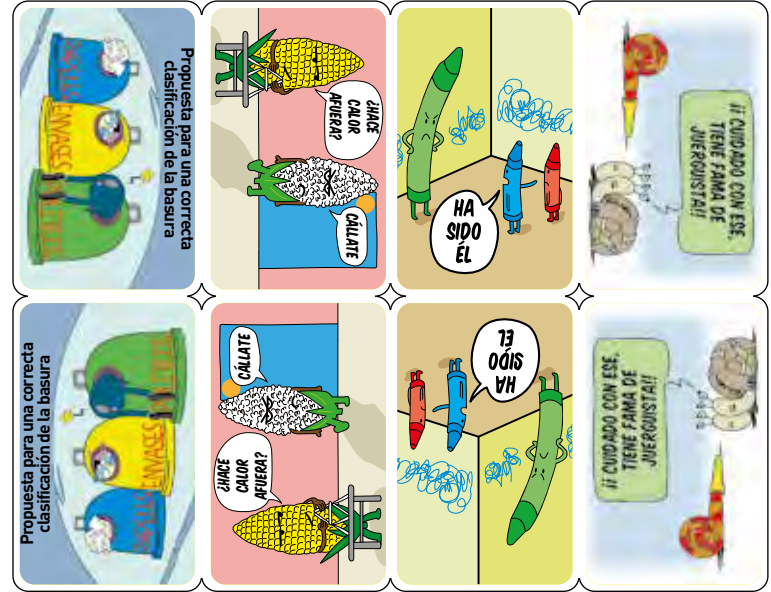

San Pancracio

Ref. 79.0008



48 cm

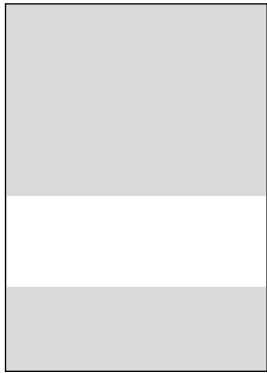

- Tamaño: 33,5 x 48 cm
- Publicidad: 31,5 x 9 cm
- Papel estucado 150 g.

Información adicional

- Los calendarios trimestrales se sirven en paquetes de 50 unidades.

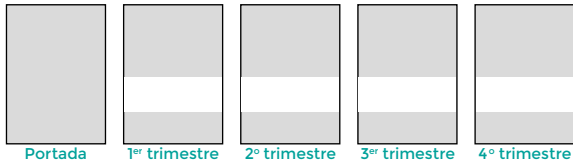

Vistas de España

Ref. 20.0226



Paisajes internacionales

Ref. 20.0227





Agua Ref. 20.0228

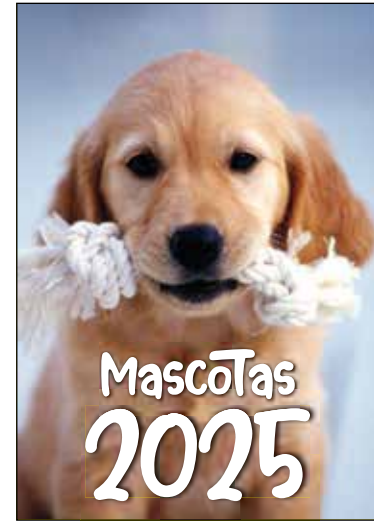

Mascotas Ref. 20.0233



Infantil Ref. 20.0230



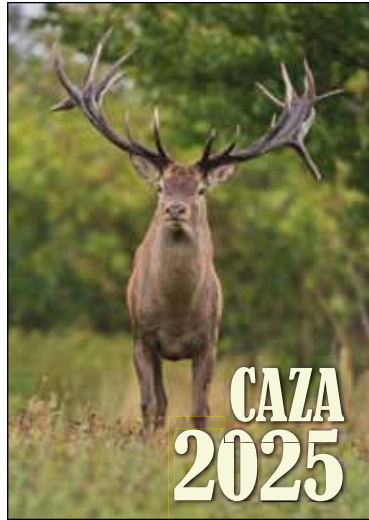

Caza

Ref. 20.0237

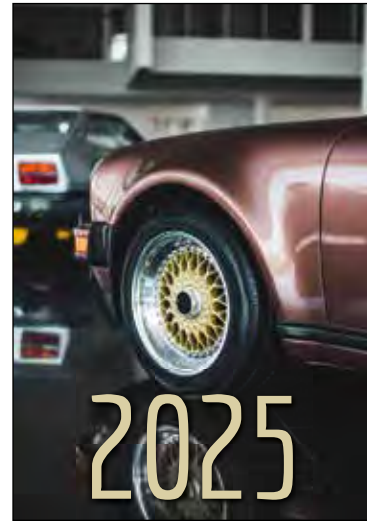

Coches

Ref. 20.0238



Religioso

Ref. 20.0239



SE Wire-O Maxi

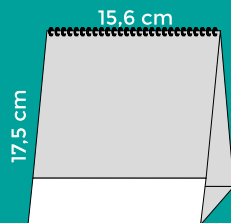

- Tamaño: 15,6 x 17,5 cm
- Calendario: 15,6 x 13,5 cm
- Publicidad: 14,5 x 3,5 cm
- Papel estucado 150 g.
- Cartón base 270 g.

SE Wire-O Estándar

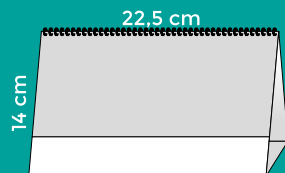

- Tamaño: 22,5 x 14 cm
- Calendario: 22,5 x 10 cm
- Publicidad: 21,5 x 3,5 cm
- Papel estucado 150 g.
- Cartón base 270 g.

SE Wire-O Mini



- Tamaño: 9,7 x 14 cm
- Calendario: 9,7 x 10 cm
- Publicidad: 8,7 x 3,5 cm
- Papel estucado 150 g.
- Cartón base 270 g.

Cartón base

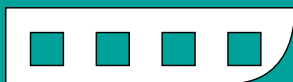

Perforado cerrado



Perforado abierto

*Detalles del cartón base en la página 86

Montado

Calendario completo montado con el wire-o y con el cartón sin imprimir.

Referencias genéricas:

- SE Wire-O Mini: 09.00XX
- SE Wire-O Estándar y Maxi: 17.00XX



Montado

Wire-O Maxi



81 Mensual Notas

7 hojas Castellano Notas

Ref.	Modalidad
17.0081	Calendario montado
17.8100	Con cartón abierto

Tamaño: 15,6 x 17,5 cm

Wire-O Mini



37 Mensual

7 hojas Castellano

Ref.	Modalidad
09.0037	Calendario montado

Tamaño: 9,7 x 14 cm

Wire-O Estándar



43 Mensual Notas

7 hojas Castellano Notas

Ref.	Modalidad
17.0043	Calendario montado

Tamaño: 22,5 x 14 cm

50 Paisajes Internacionales

7 hojas

Castellano

Ref.	Modalidad
17.0050	Calendario montado



01



02



03



04



05



06



07



08



09

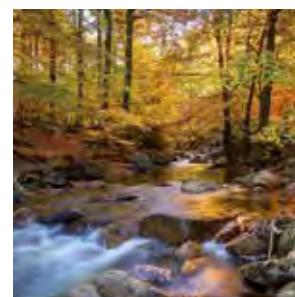

10



11



12



52 Infantil

7 hojas

Castellano

Ref. 17.0052 Modalidad Calendario montado



01



02



03



04



05



06



07



08



09



10



11

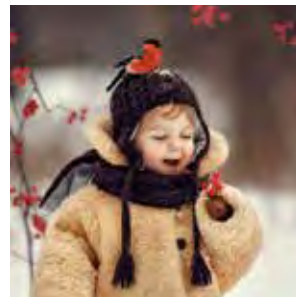

12



PUBLICIDAD

CALENDARIOS SOBREMESA WIRE-0

53 Vistas de España

7 hojas

Castellano

Notas

Ref.

Modalidad

17.0053

Calendario montado



PUBLICIDAD



01



02



03



04



05



06



07



08



09



10



11



12

54 Vistas de España

7 hojas

Castellano

Ref. 17.0054 **Modalidad** Calendario montado

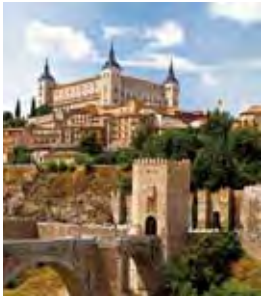

01



02



03



04



05



06



07

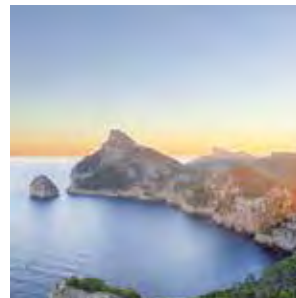

08



09



10



11



12

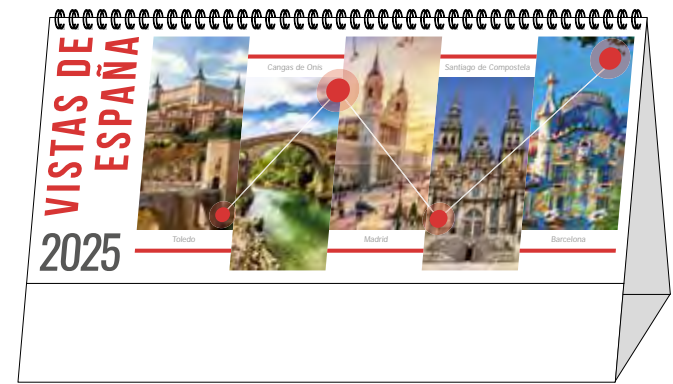

CALENDARIOS SOBREMESA WIRE-0

56 Animales

7 hojas Castellano

Ref. 17.0056 **Modalidad** Calendario montado



01

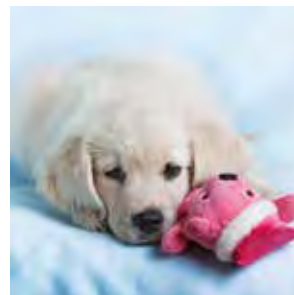

02

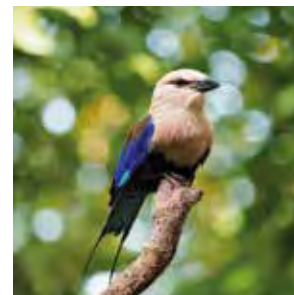

03



04



05



06



07

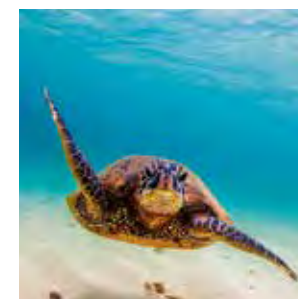

08



09



10



11



12

68 Galicia

7 hojas

Gallego

Ref.

Modalidad

17.0068

Calendario montado



01



02



03



04



05



06



07



08



09



10



11



12



PUBLICIDAD

CALENDARIOS SOBREMESA WIRE-0

CALENDARIOS SOBREMESA SEMESTRALES

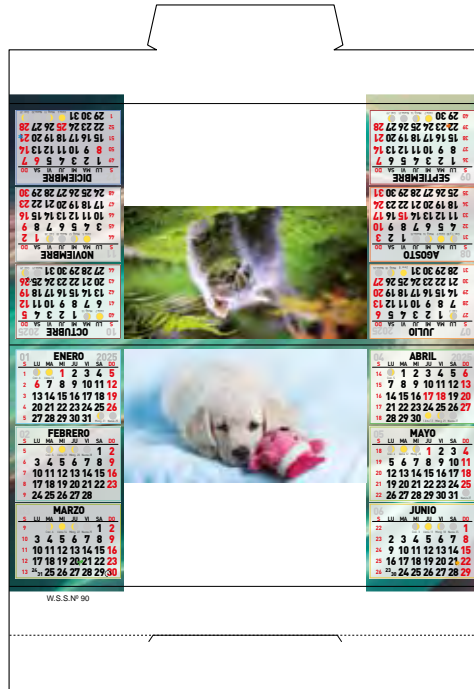

Mascotas Ref. 18.0090

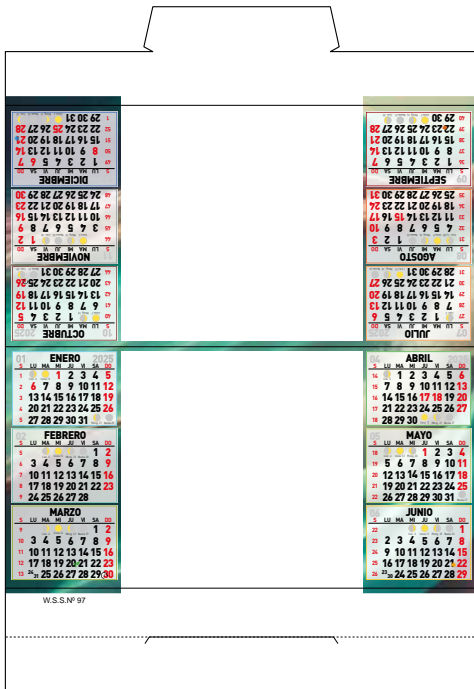

Sin foto Ref. 18.0097
Sin foto (catalán) Ref. 18.0102



Paisajes internacionales



Ref. 18.0091



Niños



Ref. 18.0092



Coches



Ref. 18.0094



Madrid



Ref. 18.0095

CALENDARIOS DE NEVERA

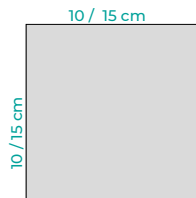

NV-S

- Tamaño: 10 / 15 cm
- 280 g folding
- Colgador: imán
- Faldillas:
 - lecheras

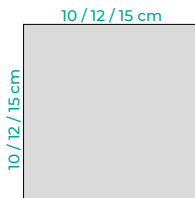

NV-M

- Tamaño: 10 / 12 / 15 cm
- 280 g folding
- Colgador: imán
- Faldillas:
 - notas

Café - Bar
O Caminante da Rúa

Carril da Flores, 52 Bj,
Tel.: **676 384 883**
ocamiñantedarua@gmail.com

PERU FARMACIA

LOS TODOS LOS DÍAS DEL AÑO
De 9h a 21h, Sábados, domingos y festivos de 9:30h a 14h
6 27 03 42 - Whatsapp 611 08 84 98
Avda. del Perú n°10. Cádiz

ENERO 2025

S	LUNES	MARTES	MIERCOLES	JUEVES	VIERNES	SÁBADO	DOMINGO
1	2	3	4	5	6	7	8
9	10	11	12	13	14	15	16
17	18	19	20	21	22	23	24
25	26	27	28	29	30	31	

NOTAS

ENERO * 2025

MÉRCOLES 1 - Día Nacional del Profesor

VIERNES 3 - Día del Niño

SÁBADO 4 - Día del Agricultor

DOMINGO 5 - Día del Pez

MARTES 7 - Día del Niño

MÉRCOLES 8 - Día del Niño

JUEVES 9 - Día del Niño

VIERNES 10 - Día del Niño

SÁBADO 11 - Día del Niño

DOMINGO 12 - Día del Niño

LUNES 13 - Día del Niño

MARTES 14 - Día del Niño

MÉRCOLES 15 - Día del Niño

JUEVES 16 - Día del Niño

VIERNES 17 - Día del Niño

SÁBADO 18 - Día del Niño

DOMINGO 19 - Día del Niño

LUNES 20 - Día del Niño

MARTES 21 - Día del Niño

MÉRCOLES 22 - Día del Niño

JUEVES 23 - Día del Niño

VIERNES 24 - Día del Niño

SÁBADO 25 - Día del Niño

DOMINGO 26 - Día del Niño

LUNES 27 - Día del Niño

MARTES 28 - Día del Niño

MÉRCOLES 29 - Día del Niño

JUEVES 30 - Día del Niño

VIERNES 31 - Día del Niño

CALENDARIOS CUBILETES

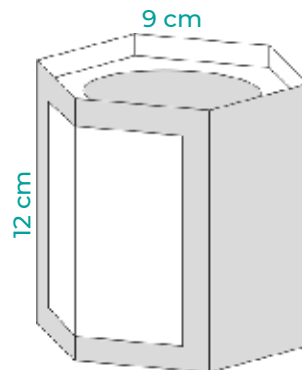

Cubilete hexagonal

- Tamaño: Ø 9 x 12 cm
- Publicidad: 8 x 11 cm
- Cartón 300 g.
- Se sirve montado con pegatina aparte
- Plastificado con reserva

2025	2025	2025	2025
ENERO	ABRIL	JULIO	OCTUBRE
FEBRERO	MAYO	AGOSTO	NOVIEMBRE
MARZO	JUNIO	SEPTIEMBRE	DECIEMBRE

Cubilete hexagonal Ref. 12.0001

CALENDARIOS DE NEVERA / CUBILETES

CALENDARIOS PERSONALIZADOS ESPECIAL DIGITAL VARILLADOS CON FALDILLA MENSUAL NOTAS

todas con 14 páginas
extra con notas

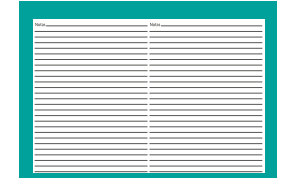
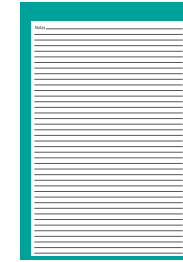

lecheros

100 mm

320 mm

150 mm

470 mm

210 mm

530 mm

También en Gallego

235 mm

550 mm

También en Gallego

235 mm

385 a 495 mm

315 mm

210 a 320 mm

También en Gallego

nevera

100 mm

200 mm

150 mm

300 mm

435 mm

230 a 320 mm

470 mm

230 a 320 mm

485 mm

230 a 320 mm

120 mm

220 mm

490 a 590 mm

490 a 590 mm

600 a 605 mm

600 a 605 mm

609 a 605 mm

609 a 605 mm

FALDILLAS

AGENDAS CAMPAÑA 2025

Con troquel mes a mes
modelo Cervantes dia a dia
sábado y domingo páginas diferentes



Recambio modelo Cervantes

ALP ID

ALMACÉN DE PAPEL DIGITAL

medidas especiales para impresoras
XEROX - KONICA - RICOH y otros

VENTAS AL POR MAYOR

SNID